

Water Softener

Operating Manual

Warning and Safety instructions

This water softener complies with all relevant local and national safety requirements. Improper use will invalidate your manufacturers warranty and could lead to injury and material damage.

To help avoid the risk of accidents and unnecessary damage to this unit, please read these instructions carefully before installation and use. Please keep these instructions in a safe place and ensure they are passed on to any future user of the unit.

Electrical safety

Only use the transformer /plug supplied, before use, ensure that the connection data on the data plate (voltage and frequency) match that of the mains electricity supply. If in any doubt, consult a qualified electrician.

Maintenance

The unit must be isolated from the electricity supply during installation, maintenance and repair work. Your water softener will benefit from regular service - please see welcome pack or call BWT on 01376 334 200 for details.

Cleaning

Please wipe clean with a damp cloth. Do not use solvent based or abrasive cleaning agents as they may cause damage to the high gloss finish.

Correct application

This appliance is intended for domestic use only, and any other use is not supported by the manufacturer and could be dangerous. BWT UK Limited cannot be held liable for damage resulting from the incorrect or improper use of this water softener.

Operation

This appliance can be used by children aged from 8 years and above and persons with reduced physical, sensory or mental capabilities or lack of experience and knowledge if they have been given supervision or instruction concerning use of the appliance in a safe way and understand the hazards involved.

Safety with children

Children must not play with the appliance and any contents therein at anytime.

Extended periods of non-use

If the property is to be left unattended for any length of time e.g. holidays, the water softener should be bypassed/ isolated from the mains water supply by reversing the 3 valve positions as shown in the installation diagram in this manual (see index for details).

After prolonged periods of non-use, ensure inlet and outlet valves are open and bypass valve is closed, and start a manual regeneration as described in Part 2 of this manual.

Protect from high & low temperatures

Important - do not install the water softener where it, or its connections (including the drain overflow lines), will be subject to temperatures under 5°C or above 40°C.

CONTENTS

	Page
Contents	1
Introduction, features and benefits	2
PART ONE	
Overview of the softening process	3
Installation and operating considerations	4-5
Installation layout	6
PART TWO	
Installing your water softener	7-8
Water hardness test	9
Programming procedure	10
PART THREE	
Additional features	11-12
Troubleshooting guide	13-14
Specification table	15
Warranty	16

INTRODUCTION

Congratulations and thank you for choosing a BWT water softener.

On the following pages we provide full installation and operating instructions. You may find this booklet easier to follow if you first take a few minutes to familiarise yourself with the basic principles of the water softening process and benefits of the "Millennium" valve.

FEATURES AND BENEFITS

At the heart of your BWT water softener is the Millennium valve controlled by the BWT "Advanced Memory Electronic Control System" (AMECS). AMECS is manufactured and tested to meet the latest EU standard for performance, safety and testing of water softeners. The protocol used in the system design is based on the extensive experience of BWT in the UK.

- Rotary valve means less moving parts for greater reliability.
- Flow rates suitable for use on conventional and modern plumbing systems.
- Custom backlit easy read display.
- Memory back-up facility allows the controller to restore all key settings held in its memory after a temporary power supply failure, (for up to 72 hours).
- Low voltage control system.
- High capacity resin for generous amounts of softened water between regenerations.

PART ONE

OVERVIEW OF THE WATER SOFTENING PROCESS

WHAT IS A WATER SOFTENER?

A water softener works by passing hard water through a cylinder containing ion exchange resin.

The resin consists of tiny beads that attract and retain the hardness minerals, allowing the now softened water into your household water supply.

Periodically, these resin beads are automatically cleaned and regenerated by rinsing with a small amount of brine, (a salt solution).

The brine, with the accumulated hardness is then flushed away to the drain.

All this takes place automatically, all that remains for you to do is occasionally top up the water softener with salt.

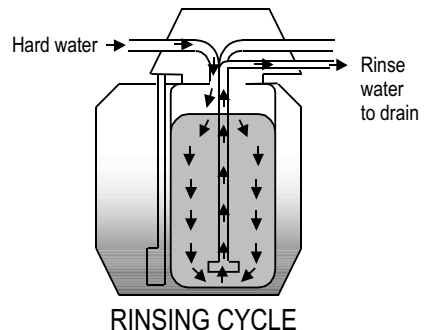
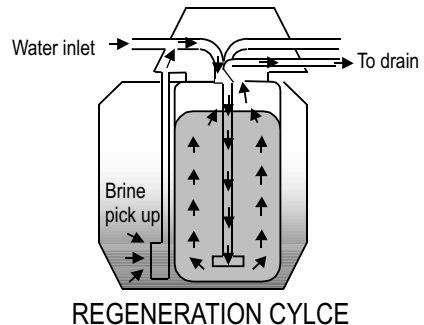
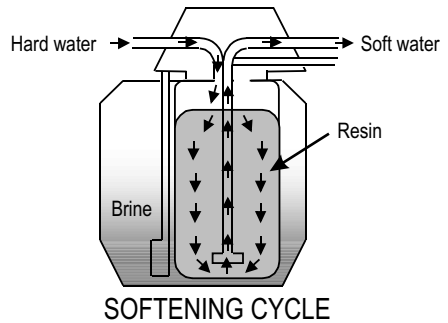

INSTALLATION AND OPERATING CONSIDERATIONS

1. Before you begin

The installation of your new water softener is relatively straightforward. However, we would recommend that either a qualified plumber or a person with relevant plumbing experience carries out the installation.

Before embarking on the installation, please ensure you have familiarised yourself with both these instructions and the components required to complete the installation.

2. Positioning the water softener

Please measure your water softener to ensure that it will fit into the area you are placing the unit into. PLEASE remember to include additional space for connecting pipe work in your calculations along with the regular access that is needed for topping the unit up with salt and future service.

Where possible, the distance of both the incoming water supply and nearest drain should be kept to a minimum. Two metres is an ideal distance, however, longer distances are permissible, dependant on the incoming water pressure.

Please remember the weight of your new water softener will considerably increase once installed and filled with salt. Therefore, please ensure your chosen location is strong enough to support an approximate total weight of 50 Kg.

Your new water softener has been designed to operate efficiently and effectively with an incoming water pressure of between 1.7 to 5 BAR. **If your water supply is likely to fall outside these limits, then we would recommend that a booster pump or pressure-limiting valve should be fitted respectively.**

PLEASE NOTE: UK Water Regulation guidelines on the installation of water softeners indicate that a minimum of one tap is left as a source of untreated water / drinking water within the home. It is also recommended that any garden taps should also be left untreated.

Important - do not install the water softener where it, or its connections (including the drain overflow lines) will be subject to temperatures under 0°C or above 49°C.

If you are planning to install the water softener above ground level e.g. In the loft, the following instructions should be strictly adhered to.

3. Loft installation

The water softener should be installed within a container of not less than 100 litre capacity, to which there should be connected an overflow pipe of not less than 20mm diameter. The overflow should be connected at the bottom of the container and not less than 150mm below the height of any electrical components mounted on the water softener. It is recommended that an anti vacuum valve be fitted to the inlet pipework supplying the water softener.

4. Plumbing systems

There are several types of plumbing systems in common use:

Static Head These systems are fitted with storage tanks. The water softener can be installed using the standard 15mm installation kit supplied with your softener.

Systems using Combination Boilers (15mm) For these systems, we recommend that your water softener be “hard plumbed” using copper tube or flexible high flow hoses, (braided high flow hoses are available from your dealer or direct from BWT).

Unvented Fully Pressurised Systems (22mm) As for combination boilers above.

5. Backflow prevention device

When fitted to the supply feeding a single dwelling, a check valve complying with BS6282 Part 1 must be fitted on the cold water feed prior to the installation. All other types of installation require the fitting of a double check valve.

6. Drinking water

Your water softener installation must include at least one drinking water tap that is not fed by the water softener.

It is recommended that individuals on a low sodium diet should follow the Department of Health's advice that water from a domestic water softener should not be used for drinking or cooking. Softened water contains a small amount of sodium, it has been calculated that 1 pint of softened water contains a similar amount of sodium as two slices of white bread or ¼ pint of milk.

Water that is used for mixing powdered milk for babies must only be taken from an unsoftened mains tap as some powdered milks and softened water both contain sodium for which young babies have a limited tolerance.

INSTALLATION LAYOUT

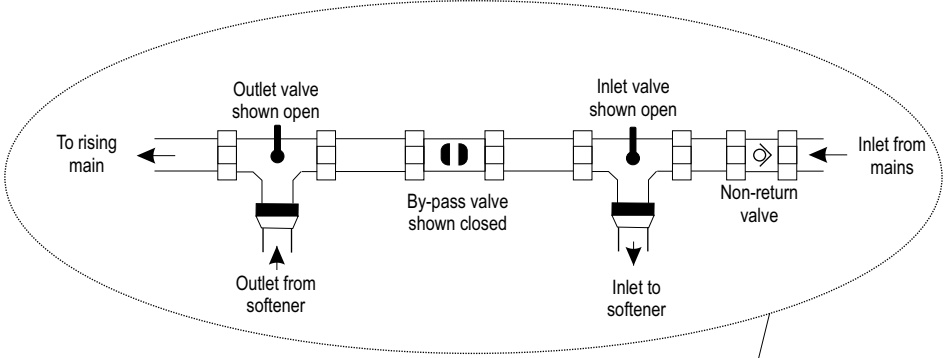

Key to the diagram

- A. Non return valve
- B. Pressure reducing valve (where required)
- C. Inlet valve
- D. Bypass valve
- E. Outlet valve

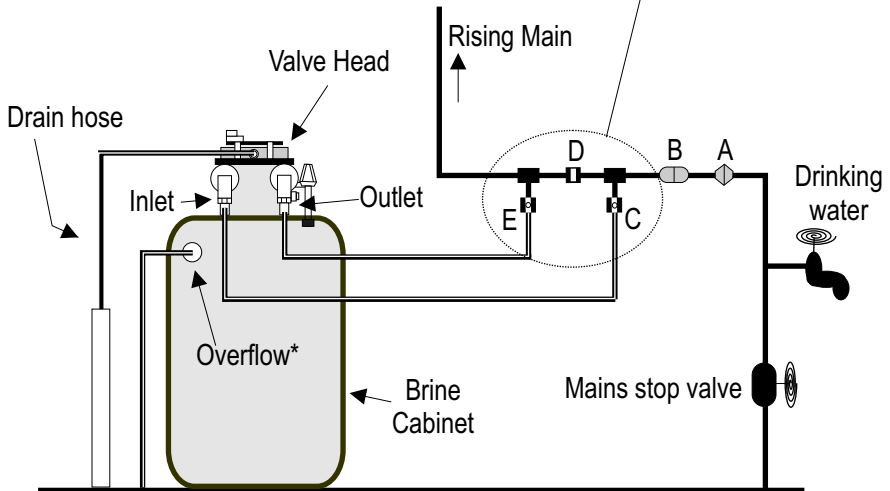

* The overflow must discharge to a place that is visible outside the building.

PART TWO

INSTALLING YOUR WATER SOFTENER

1. Positioning the water softener

It is very important to establish the water pressure before installing the water softener. If the water pressure is low then the water softener may not operate effectively. If it is too high, then components inside the unit may be damaged.

Water pressure should be tested with a gauge at the kitchen tap or outside tap. It should be noted that water pressure can increase at periods of low water usage e.g. overnight. **If therefore, the daytime pressure exceeds 5 BAR or if you are unsure about pressure, then a pressure-limiting valve should be fitted.**

Where the pressure is less than 1.7 BAR a booster pump may be required.

2. Inlet and outlet connections

With the bypass valve open and the inlet / outlet valves closed the unit can be connected to the plumbing system. Arrows on the inlet and outlet piping from the valve will confirm the direction of flow.

Connections can be made in one of three ways - where high flow rates are not required (static head systems) these connections can be made using the flexible hoses supplied with the water softener, ensure the hoses are not kinked as this may restrict flow. For systems requiring higher flow rates (those fitted with combination boilers or unvented pressurised systems) the connections should be made using specialist high flow hoses or conventional copper tube and fittings.

3. Drain connection

Push the flexible drain hose onto the barbed connector (Drain) as shown on page 6 and secure with the clip provided. Run the drain hose to a stand pipe or to a drain. The air gap needs to be at least 20mm. Softened water will have no adverse effect on a septic tank. You can extend the drain up to 9m if you have sufficient pressure (greater than 3 BAR). The drain hose must not be kinked or restricted in any way as this will cause an overflow from the brine cabinet.

Frost protection

If the drain hose or connecting pipework is likely to be subject to temperatures below 0°C it must be protected to prevent freezing. Failure to observe this precaution could lead to the water softener overflowing.

Raising the drain hose

If you have a water pressure of 3 BAR or more, you can raise the drain to a maximum of 3 metres above the valve head.

4. Overflow connections

An overflow pipe should be connected to the push fit elbow at the rear of the cabinet (see page 6). Run the pipe downhill to the outside of the building. Take care that the overflow does not discharge where damage could occur.

If the water softener is fitted in a cellar or basement, the overflow can be run to a storage tank. Do not elevate the overflow hose. Do not use jointing cement on the fitting. **Do not join the overflow and drain hose.**

5. Electrical connections

For added safety, peace of mind and ease of installation, your water softener is powered by low voltage via a plug in transformer. This transformer must be connected to a fused switched socket. Plug the transformer into the socket with the switch in the OFF position.

6. Filling the brine cabinet, salt usage and salt alarm

Now place the water softener salt in the brine cabinet. You should only use granular or tablet salt specifically made for water softeners. We recommend Care Crystals, which are made to the highest quality standards and can be purchased from the retailer that supplied your water softener.

If you need assistance in finding your local supplier telephone BWT on, 01376 334200.

Prime the system, add approximately 6 litres of cold water to the brine cabinet.

Notes on salt usage

Your water softener will only perform effectively if there is salt in the brine cabinet during the regeneration process. It is therefore essential that the salt level does not fall lower than 150mm in depth when measured from the base of the brine cabinet.

During regeneration, salt will not enter your water system as the salt used in the regeneration process is rinsed safely away to drain.

7. Blending control

All machines are factory set to produce water that is soft. If you prefer water which is less soft, turn the blending knob on the left side of the valve anti-clockwise until the water meets your requirements.

NB: Some softener models do not have blending control.



8. Testing for the water hardness in your area

Water hardness can vary from one location to another. To determine the hardness of the water feeding your water softener (un-softened supply) use the hardness test kit supplied.

- Fill the test bottle supplied to the fill line with water from a hard water tap.
- Add the tablets to the solution one tablet at a time.
- Shake the bottle in between and keep adding tablets to the water until the solution turns from wine red to blue, record the number of tablets as you go.
- Using the data table supplied with your kit, match up the number of tablets with the hardness. You will need this figure when programming your water softener in the next section of this manual.

9. Switching on for the first time

- Check that the inlet / outlet hoses or couplings are properly connected i.e. inlet-to-inlet, outlet-to-outlet.
- The by-pass arrangement should be in the open position i.e. the inlet and outlet valves closed, by-pass valve open. Mains stop valve open.
- Check that the Brine Cabinet contains salt and water.
- Check that the water softener is connected to the drain and the overflow pipe is connected. The drain and overflow **must not** be linked to each other.



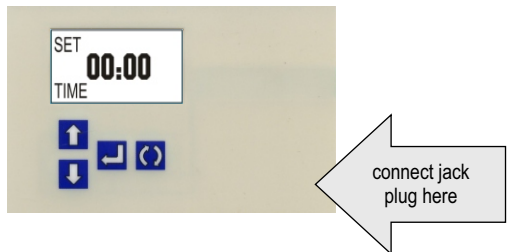

- Connect the jack plug of the power lead to the socket at the bottom right corner of the control box.



- Gently open the inlet valve so that water flows into the resin vessel.
- Switch on the power, you will hear the valve move quietly into the start position. When the positioning process has been completed (which can take up to 10 minutes) you will hear the movement stop, the valve has now reached its start position in preparation for the programming procedure.
- Close the by-pass valve.
- Gently open the outlet valve.
- Check for leaks, take corrective action to stop leaks if required.
- Your water softener is now on line and you may start the valve programming procedure set out in the next section of this manual.

PROGRAMMING PROCEDURE

1. SETTING THE TIME OF DAY

The first two digits (00) of the display will flash prompting the installer to set the time. The time is adjusted by using the   keys. Pressing the  key enters the hours. The minutes are set by using the   keys, (see Fig 1).

Pressing the  key once enters the minutes and moves the display into the Set Hardness mode (Metered version) or Set Recharge Frequency Mode (Timed version).

Fig 1

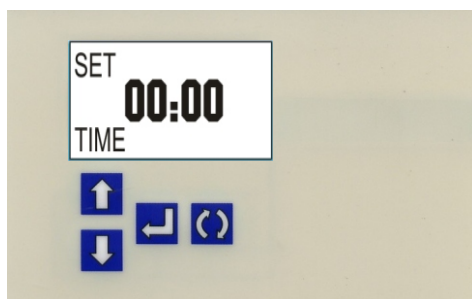

Fig 2a

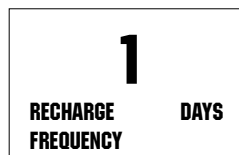







Fig 2b

2a. SETTING THE WATER HARDNESS (Metered version)

The display default is 300 (typical hardness level, see Fig 2a) which indicates a setting suitable for hard water with a value of 300 parts per million of hardness minerals. Use the   keys to adjust the setting to match that of the one you obtained / identified earlier. See page 9 for details.

2b. SETTING THE RECHARGE FREQUENCY (Timed version)

The display default is 1, which indicates a setting for the water softener to recharge every day. Use the   keys to adjust the setting to the required recharge frequency. Refer to setting chart on Page 15 for recommended regeneration frequencies.

Pressing the  button will return the display to the Normal Operation mode.



Programming is now complete and no further adjustment of the water softener is required.

Remember to check the salt level in the brine cabinet weekly.

PART THREE

ADDITIONAL FEATURES

3. Resetting the display during normal operation.

If the time is to be adjusted during normal operation, press any key to illuminate the display, press the  key once. The display will flash and indicate present time. Using the   keys will alter the time as described on page 10.



4. Power loss

The AMECS system will maintain the individual programming parameters of the water softener for up to 72 hours.

If the power cut lasts longer than 72 hrs, the control will flash "00:00" when power is returned to the control. The unit will continue to keep time from the moment power is restored. In this situation the time of day will need to be reset.

5. Manual regeneration (button)

Under normal operating conditions your water softener will regenerate automatically and you should not normally have to regenerate the unit manually. If however a manual regeneration is required then follow the procedure set out below.

1. Press any key to illuminate the display.
2. Momentarily pressing the  button (symbol underneath the display and furthest to the right) will illuminate Recharge Tonight on the display and perform a regeneration at 2.00a.m. regardless of the remaining water softener capacity.
13. If the  button is subsequently pressed, this will clear the Recharge Tonight indicator from the display and cancel the Recharge Tonight feature.
4. If the  is pressed down for three seconds, the controller will flash the Recharge display and immediately commence the regeneration cycle which cannot be cancelled once started.

6. Flow indicator

During normal operation, a flow indicator will flash on the display at a rate of one litre per pulse when water is passing through the softener.

7. Salt usage

Your water softener is controlled by a microprocessor which constantly monitors water usage. The system will build up a history of your water requirements and calculate the most economical regeneration pattern. This will ensure a constant supply of softened water whilst maintaining high levels of water and salt efficiency.

8. Increase in number of residents

Sudden changes in your water usage should not affect your water softeners performance. If however, the number of guests staying with you increases, you will notice that the water usage patterns will alter. This may cause your water softener to regenerate more often than normal. As the water usage returns to its normal level, the number of regenerations will also return to normal.

9. Cleaning

Your water softener may be cleaned using a damp cloth and a mild detergent. Do not use bleaches, solvents or spirits as they may damage the surfaces.

10. Cabinet Water Level

During normal operation the water level inside the water softener cabinet will rise and fall as required by the regeneration process. If the water softener is used within the specified operational parameters the water level should not reach the overflow connection. If however an overflow situation occurs please refer to the troubleshooting section on page 13 to diagnose the problem.

Following any overflow situation reduce the water level by half and initiate a manual regeneration as described on page 11.

NB: Check the water level weekly and following any unplanned event, e.g. power failure.

PART THREE

TROUBLESHOOTING GUIDE

IF YOUR WATER SOFTENER IS NOT PERFORMING AS IT SHOULD, PLEASE RUN THROUGH THE CHECK LIST BELOW

CHECKLIST	SOLUTION	Page	Section
PROBLEM: WATER STILL REMAINS HARD			
Is there a minimum of 150mm of salt in the brine cabinet?	Fill the brine cabinet with salt.	8	6
Is the power on?	Switch the power on and check connections.	8	5
Is the softener online?	Close the by-pass valve and open the inlet and outlet valves.	9	9
Is the hardness setting correct?	Reset the hardness if required.	9	8
PROBLEM: WATER LEVEL IN BRINE CABINET REACHES OVERFLOW			
Is the line pressure within the specification of the water softener?	Connect a pressure gauge to a water outlet and check the pressure is between 1.7 - 5.0 bar.	7	1
Pressure falls outside of the water softener specification.	Fit a pressure reducing valve or booster pump as required.	7	1
Is there flow through the drain line?	Check the drain line is not kinked, blocked or frozen.	7	3
Has there been a power interruption?	Check that the power is on and the connections are secure.	8	5

Note: If any overflow situation occurs or if any of the above requires action reduce the water level by half and initiate a regeneration by pressing and holding the manual regeneration key  for more than three seconds.

CHECKLIST	SOLUTION	Page	Section
PROBLEM: NO WATER			
Is the mains stop valve open?	Open the mains stop valve.	9	9
Are the inlet and outlet valves of the water softener open?	Open the inlet and outlet valves to the water softener.	9	9
PROBLEM: WATER RUNS FROM THE DRAIN CONSTANTLY			
Is the unit in recharge mode?	If yes, this is normal, wait until the recharge is complete.	3	
	There should be no flow to drain in the service position. Isolate the softener and call for service.	9	9
PROBLEM: EXCESSIVE SALT USAGE			
Check the hardness setting.	Reduce the hardness if incorrect.	9	8
PROBLEM: ELECTRONIC DISPLAY			
The display shows error code "Err 1", audible alarm sounds, (see note below).	Check all the connections are secure. Turn the power off for 10 seconds then turn back on, allow the system to reset.	8	5
Is the digital display blank?	Check the power is turned on and all the connections are secure.	8	5
PROBLEM: UNIT REGENERATES AT THE WRONG TIME			
Is the present time correct?	Reset the present time.	11	3

Note. If the home position is not detected within 10 minutes, the main display will show an Err 1 message to indicate a controller error and an audible alarm will sound. The error condition can only be cleared by removing and re-applying the power.

IF PROBLEM PERSISTS, PLEASE CALL YOUR BWT DEALER OR CONTACT OUR TECHNICAL HELP DESK ON 01376 334200

SPECIFICATION TABLE

Model	10 Litre	14 Litre
Maximum peak flow rate L/min*	50	50
Maximum continuous flow rate L/min	30	35
Basic flow rate (flow @ 1 bar pressure loss)	24	28
Minimum flow rate L/min*	10	10
Salt usage per regeneration Kg	0.84	1.12
Maximum pressure (bar)	5	5
Minimum pressure (bar)	1.7	1.7
Maximum water temperature	49	49
Minimum water temperature	5	5
Primary voltage a.c. (transformer)	230	230
Secondary voltage d.c. (controller)	12	12
Inlet / outlet connections (BSP)	3/4"	3/4"
Drain connection (tube)	1/2"	1/2"

Notes

* Flow rates are from 10 and up to a peak of 50 litres / min. At flow rates under 10 litres / min the hardness may not be effectively removed from the water. If peak flow rates are sustained for longer than 10 minutes the softener capacity may be reduced resulting in hard water breakthrough.

The regeneration chart is a guide and based on industry standards. Naturally everyone's usage will vary and the regeneration interval can be altered to suit.

Regeneration setting chart for timed softeners					
No. of people Hardness in PPM	2	3	4	5	6
150	8	7	6	5	4
200	7	6	5	4	3
250	6	5	4	3	2
300	5	4	3	2	1
350	4	3	2	1	1
400	3	2	2	1	1
Days between regeneration					

WATER SOFTENER WARRANTY

Your new water softener has been designed to give you many years of satisfactory service and is guaranteed against faulty materials and workmanship for a period of 12 months from the date of purchase. Under the provision of this the warranty agreement the warranty liability is limited to the repair or replacement cost of the unit only and is subject to the terms shown below.

Conditions and Terms of the Warranty:

This warranty provides benefits, which are additional to, and do not affect, your legal rights. BWT will replace or exchange any necessary parts to repair free of charge any domestic water softener supplied by BWT or it's agents, located within the United Kingdom,* which is shown to the satisfaction of BWT to be defective due to faulty workmanship or materials within 12 months from the date of Installation. If any domestic water softener has in BWT's opinion been used for commercial purposes the period of cover will be reduced to 6 months.

What services and associated costs are not included?

Repairs due to breakdown caused by but not limited to:

Use of the unit for purposes for which it was not designed or intended.

Incorrect installation e.g. the failure to follow instructions or advice given by BWT or its representatives.

Any defect caused by malicious or wilful action, negligence, misuse or third party interference.

Any defect or damage occasioned by fire, lightening, explosion, flood, storm, frost impact or other extraneous cause.

Consequential loss arising as a result of a defect occurring in the water softener or installation.

Any defect or damage arising as a result of failure in the public electricity supply.

Any damage to equipment other than the water softener caused as a result of hard water.

Any damage to fixtures and fittings other than the water softener caused as a result of softened water.

Any salt used or wasted as a result of a defect or damage to the water softener.

Repair cost for: -

Consumer replaceable items including but not limited to filters, batteries and light bulbs.

Associate items that are not part of the unit, including but not limited to, pipe work and electrical connections.

The expense of a service call when the service engineer finds no fault.

Extended Warranties

In addition to the standard 12 month warranty, BWT can offer you the option to further extend this protection for a further two or four years with one of their unique warranty and service plans that provide the peace of mind offered by an extended warranty, the practical benefits of a service plan and premium grade salt delivered to your door**

For further details please see the literature supplied with your new water softener or Phone 01376 334200
* UK Mainland Only ** Subject to Location



Head Office: BWT UK Limited, BWT House, Coronation Road
High Wycombe, Buckinghamshire, HP12 3SU

Tel: 01494 838 100 Fax: 01494 838 101
Email: enquiries@bwt-uk.co.uk